

DH-SD6C23C-H

23x Cost-effective IR PTZ Dome Camera



Key Features

- Powerful 23x optical zoom
- High resolution@700TVL/650TVL/540TVL
- DWDR, Day/Night (ICR), DNR (2D&3D), Auto iris, Auto focus
- Max 240°/s pan speed, 360° continuous pan rotation
- Up to 255 presets, 5 auto scan, 8 tour, 5 pattern
- IP66, IR distance up to 100m

DH-SD6C23C-H

Technical Specifications:

Model	SD6C23C-H
Camera	
Image Sensor	1/4"CMOS
Effective Pixels	640(H) × 480(V)
Horizontal Resolution	Color: 540TVL
Scanning System	Progressive
Electronic Shutter Speed	1/50(60)s~1/100,000s
Min. Illumination	Color:0.5Lux/F1.6 B/W: 0Lux(IR on)
S/N Ratio	More than 50dB
Video Output	BNC(1.0Vp-p/75Ω), PAL / NTSC
Camera Features	
Day/Night	Auto(ICR) / Color / B/W
Backlight Compensation	BLC
White Balance	Auto, ATW, Indoor, Outdoor, Manual
Gain Control	Auto / Manual
Noise Reduction	2D
Privacy Masking	N.A.
Digital Zoom	N.A.
Lens	
Focal Length	3.9 mm~89.7mm; 23x Optical zoom
Max Aperture	F1.6~ F3.7
Focus Control	Auto / Manual
Angle of View	H: 53.5° ~2.6°
Close Focus Distance	100mm~1000mm
PTZ	
Pan/Tilt Range	Pan: 0° ~ 360° endless; Tilt: -15° ~ 90°, auto flip 180°
Manual Control Speed	Pan: 0.1° ~ 160°/s; Tilt: 0.1° ~120°/s
Preset Speed	Pan: 240°/s; Tilt:200°/s
Preset	300
PTZ Mode	5 Pattern, 8 Tour, Auto Pan, Auto Scan
Speed Setup	Human-oriented focal length/ speed adaptation
Power up Action	Auto restore to previous PTZ and lens status after power failure
Idle Motion	Activate Preset/Pan/Scan/Tour/Pattern if there is no command in the specified period

DH-SD6C23C-H

Time Task	Auto activation of Preset/Pan/Scan/Tour/Pattern by preset-time
Protocol	DH-SD, Pelco-P/D (Auto recognition)
IR Distance	100m
Auxiliary Interface	
RS485	1 port
General	
Power Supply	AC24V/3A (±10%)
Power Consumption	15W, 28W(IR on, Heater on)
Working Environment	-40°C ~ 60°C / Less than 90% RH
Ingress Protection	IP66
Dimensions	Φ204.7(mm) x 335.9(mm)
Weight	5.0kg

Dimensions (mm)

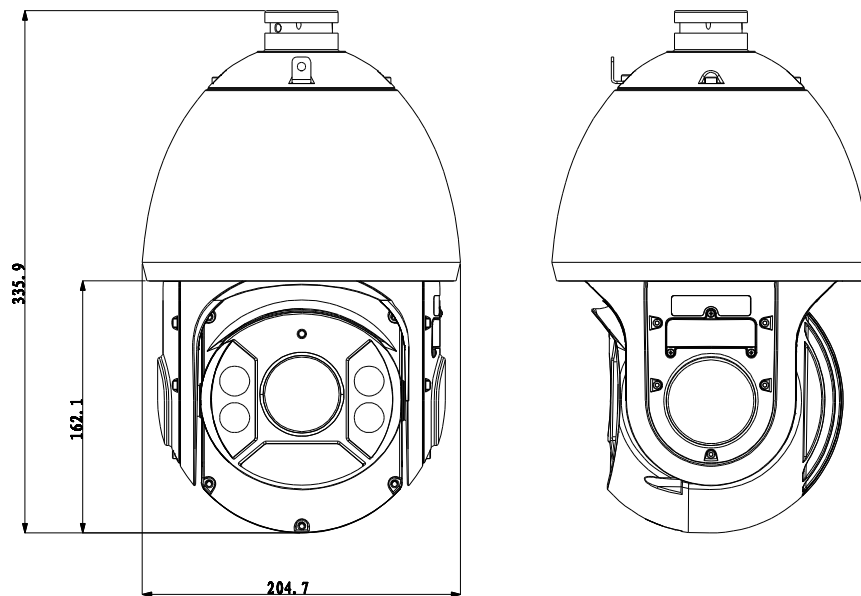







DH-SD6C23C-H

Accessories

	
DH-64FB	Power Supply

Accessories (Optional)

			
DH-PFA114	DH-PFB300C	DH-PFA112	DH-PFA113

		
DH-PFA120	DH-PFA150	DH-PFA151

Dahua Technology Co., Ltd.

1187 BinAn Road, Binjiang District, Hangzhou, China

Tel: +86-571-87688883

Fax: +86-571-87688815

Email: overseas@dahuatech.com

www.dahuasecurity.com

*Design and specifications are subject to change without notice.

© 2013 Dahua Technology